

Table of contents

Warning	2
Unpacking Instructions.....	2
Safety Instructions	2
Operating Determinations	4
Overview	4
Microphone channel	5
Monitor section.....	5
Main channels	6
Master section	7
Bluetooth section	7
Rear	8
Connection Example	9
Connection Cables	10
Connect a Bluetooth device	11
Maintenance	11
Troubleshooting	11
Product Specifications	12
Dimensions	13
Notes	14

Warning



**FOR YOUR OWN SAFETY, PLEASE READ THIS USER MANUAL CAREFULLY
BEFORE YOUR INITIAL START-UP!**



Unpacking Instructions

Immediately upon receiving this product, carefully unpack the carton and check the contents to ensure that all parts are present and have been received in good condition. Notify the dealer immediately and retain packing material for inspection if any parts appear damaged from shipping or the carton itself shows signs of mishandling. Save the carton and all packing materials. In the event that a fixture must be returned to the factory, it is important that the fixture be returned in the original factory box and packing.

Your shipment includes:

- DAP Audio Core Scratch
- AC Power adapter
- User manual



CAUTION!
Keep this device away from rain and moisture!



Safety Instructions

Every person involved with the installation, operation and maintenance of this system has to:

- be qualified
- follow the instructions of this manual



CAUTION! Be careful with your operations.
**With a dangerous voltage you can suffer
a dangerous electric shock when touching the wires!**



Before you initial start-up, please make sure that there is no damage caused by transportation. Should there be any, consult your dealer and do not use the system.

To maintain perfect condition and to ensure a safe operation, it is absolutely necessary for the user to follow the safety instructions and warning notes written in this manual.

Please consider that damages caused by manual modifications to the system are not subject to warranty.

This system contains no user-serviceable parts. Refer servicing to qualified technicians only.

IMPORTANT:

The manufacturer will not accept liability for any resulting damages caused by the non-observance of this manual or any unauthorized modification to the system.

- Never let the power-cord come into contact with other cables! Handle the power-cord and all connections with the mains with particular caution!
- Never remove warning or informative labels from the unit.
- Never use anything to cover the ground contact.
- Never leave any cables lying around.
- Do not insert objects into air vents.
- Do not connect this system to a dimmer pack.
- Do not switch the system on and off in short intervals, as this would reduce the system's life.
- Do not open the device and do not modify the device.
- Do not drive the inputs with a signal level bigger, than required to drive the equipment to full output.
- Do not plug Mics into the console (or stag box) while Phantom Power is on. Also mute the monitor / Pa system when turning Phantom Power on or off. Allow the system to adjust for a couple of seconds, before setting the input gains.
- Only use system indoor, avoid contact with water or other liquids.
- Avoid flames and do not put close to flammable liquids or gases.
- Always disconnect power from the mains, when system is not used. Only handle the power-cord by the plug. Never pull out the plug by tugging the power-cord.
- Always operate the unit with the AC ground wire connected to the electrical system ground.
- Make sure you don't use the wrong kind of cables or defective cables.
- Make sure that the signals into the mixer are balanced, otherwise hum could be created.
- Make sure you use DI boxes to balance unbalanced signals; All incoming signals should be clear.
- Make sure that the available voltage is not higher than stated on the rear panel.
- Make sure that the power-cord is never crimped or damaged. Check the system and the power-cord from time to time.
- Please turn off the power switch, when changing the power cord or signal cable, or select the input mode switch.
- Extreme frequency boosts in connection with a high input signal level may lead to overdriving your equipment. Should this occur, it is necessary to reduce the input signal level by using the INPUT control.
- To emphasize a frequency range, you don't necessarily have to move its respective control upward; try lowering surrounding frequency ranges instead. This way, you avoid causing the next piece of equipment in your sound path to overdrive. You also preserve valuable dynamic reserve ("headroom")
- Avoid ground loops! Always be sure to connect the power amps and the mixing console to the same electrical circuit to ensure the same phase!
- If system is dropped or struck, disconnect mains power supply immediately. Have a qualified engineer inspect for safety before operating.
- If the system has been exposed to drastic temperature fluctuation (e.g. after transportation), do not switch it on immediately. The arising condensation water might damage your system. Leave the system switched off until it has reached room temperature.
- If your Dap Audio device fails to work properly, discontinue use immediately. Pack the unit securely (preferably in the original packing material) and return it to your Dap Audio dealer for service.
- Repairs, servicing and electric connection must be carried out by a qualified technician.
- For replacement use fuses of same type and rating only.
- WARRANTY: Till one year after date of purchase.



Disposing of this product should not be placed in municipal waste and should be separate collection.

Operating Determinations

- This device is not designed for permanent operation. Consistent operation breaks will ensure that the device will serve you for a long time without defects.
- The minimum distance between light-output and the illuminated surface must be more than 0.5 meter.
- The maximum ambient temperature $t_a = 45^{\circ}\text{C}$ must never be exceeded.
- The relative humidity must not exceed 50 % with an ambient temperature of 35°C .
- If this device is operated in any other way, than the one described in this manual, the product may suffer damages and the warranty becomes void.
- Any other operation may lead to dangers like short-circuit, burns, electric shock, crash, etc.

You endanger your own safety and the safety of others!

Overview

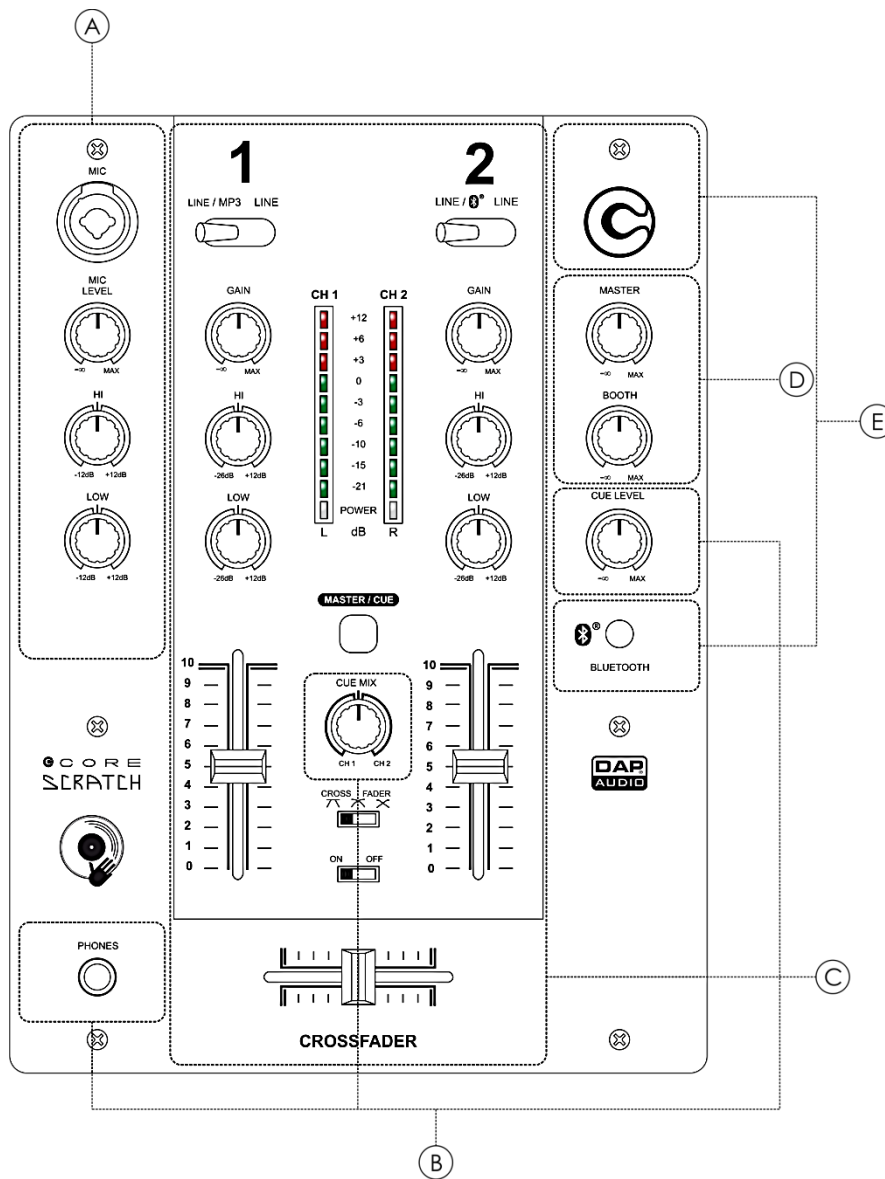

- (A) Microphone channel
- (B) Monitor section
- (C) Main channels

- (D) Master section
- (E) Bluetooth section

Microphone channel

- ① **Mic input**
Connect a microphone here.
- ② **Level control**
Adjusts the sound level output from the MIC channel.
- ③ **High control**
The High control adjusts the High frequency range.
Range: -26dB to +12dB at 10kHz.
- ④ **Low control**
The Low control adjusts the Low frequency range.
Range: -26dB to +12dB at 100Hz.

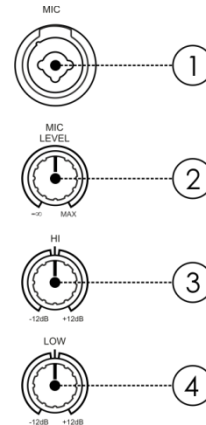

Monitor section

- ⑤ **Phones output**
The PHONES output lets you plug in your headphones.
- ⑥ **Cue mix control**
This adjusts the signal of the phones output, between channel 1 and channel 2.
- ⑦ **Cue level**
Adjusts the headphone output sound level.

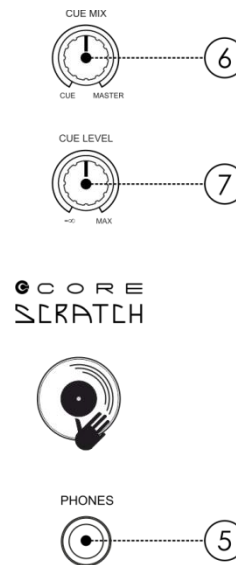

Main channels

- ⑧ **Selection switch (Line (31)/Line (32))**
Assign Line (31) or Line (32) to Channel 1.
- ⑨ **Selection switch (Line (28)/Line (29))**
Assign Line (28) or Line (29) to Channel 2.
- ⑩ **Gain control**
Adjusts the level of the audio signal input in each channel.
- ⑪ **High control**
The High control adjusts the high frequency range.
Range: -26dB to +12dB at 10kHz.
- ⑫ **Low control**
The Low control adjusts the low frequency range.
Range: -26dB to +12dB at 100Hz.
- ⑬ **Master/Cue button**
The Master/Cue button is designed to switch between "Master signal" or Input signal" on the VU meter..
- ⑭ **Channel fader**
Adjusts the level of the audio signal output in each channel.
- ⑮ **Crossfader slope switch**
This switches the crossfader curve characteristics.
- ⑯ **Crossfade ON/OFF**
Switch On/OFF crossfade.
- ⑰ **Crossfader**
Outputs audio signals assigned by the crossfader assign switch corresponding to the curve characteristics selected by the Cross Fader Curve Selector Switch.

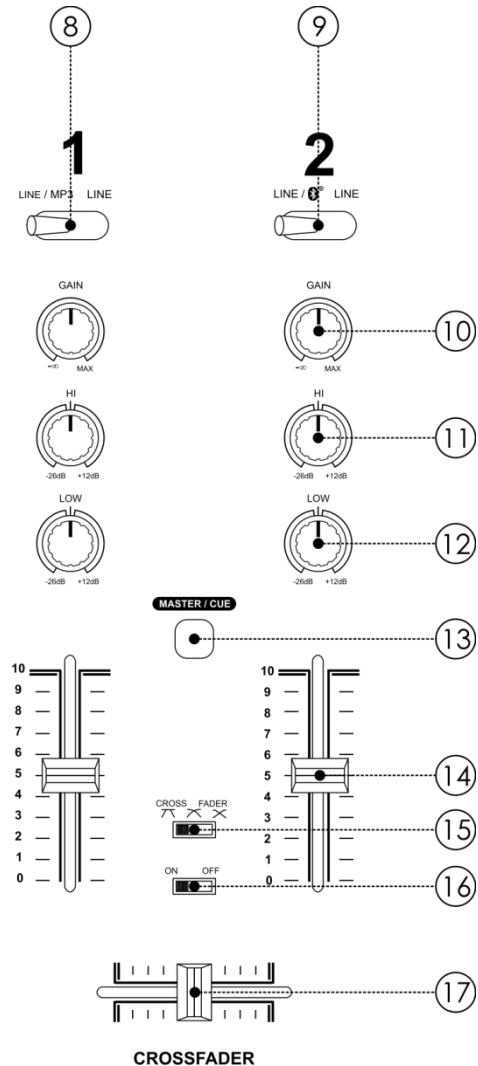

Master section

18 Output L/R signal VU meter
 Displays the audio level output from the MASTER terminal.

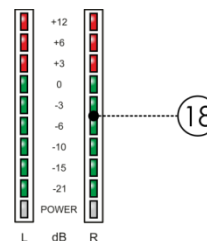

19 Master volume control
 Adjusts the audio level output from the MASTER terminal.

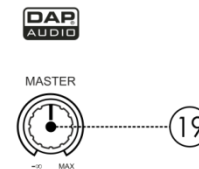

20 Booth volume control
 Adjusts the audio level output from the Booth monitor.



Bluetooth section

21 Bluetooth Pair/Unpair button
 Push the Pair/Unpair button to pair a Bluetooth® device or to disconnect a paired Bluetooth device.



22 Bluetooth connectivity LED
 Displays the status of the Bluetooth connectivity.
 When the LED is blinking, the device is in matching state.
 When the light is constantly on, a device is connected to the Core Scratch mixer.

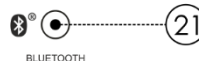

Rear

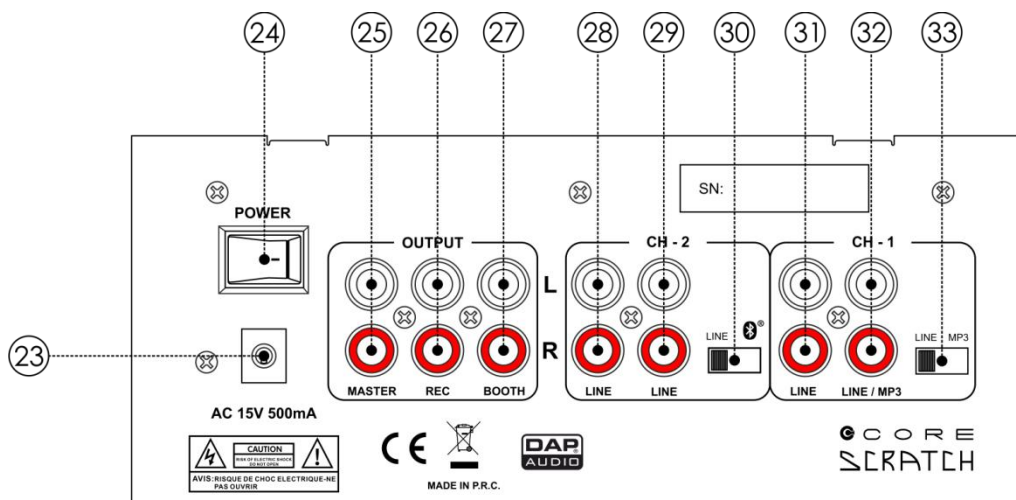

- ②③ **AC adapter inlet**
Connects to a power outlet using the included AC power adapter.
- ②④ **Power switch**
Turns this unit's power on and off.
- ②⑤ **Master RCA unbalanced output**
Connect to a power amplifier, etc.
- ②⑥ **Record RCA unbalanced output**
These are output terminals for recording.
- ②⑦ **Booth RCA unbalanced output**
These are output terminals for a booth monitor.
- ②⑧ **Channel 2 RCA unbalanced input**
Connect to a DJ player or a line level output component.
- ②⑨ **Channel 2 RCA unbalanced input**
Connect to a DJ player or a line level output component.
- ③① **Line – Bluetooth switch**
Select input source Line – Bluetooth.
- ③② **Channel 1 RCA unbalanced input**
Connect to a DJ player or a line level output component.
- ③③ **Channel 1 RCA unbalanced input**
Connect to a DJ player or a line level output component.
- ③④ **Line – MP3 player switch**
Select input source Line - MP3 player

Connection Example

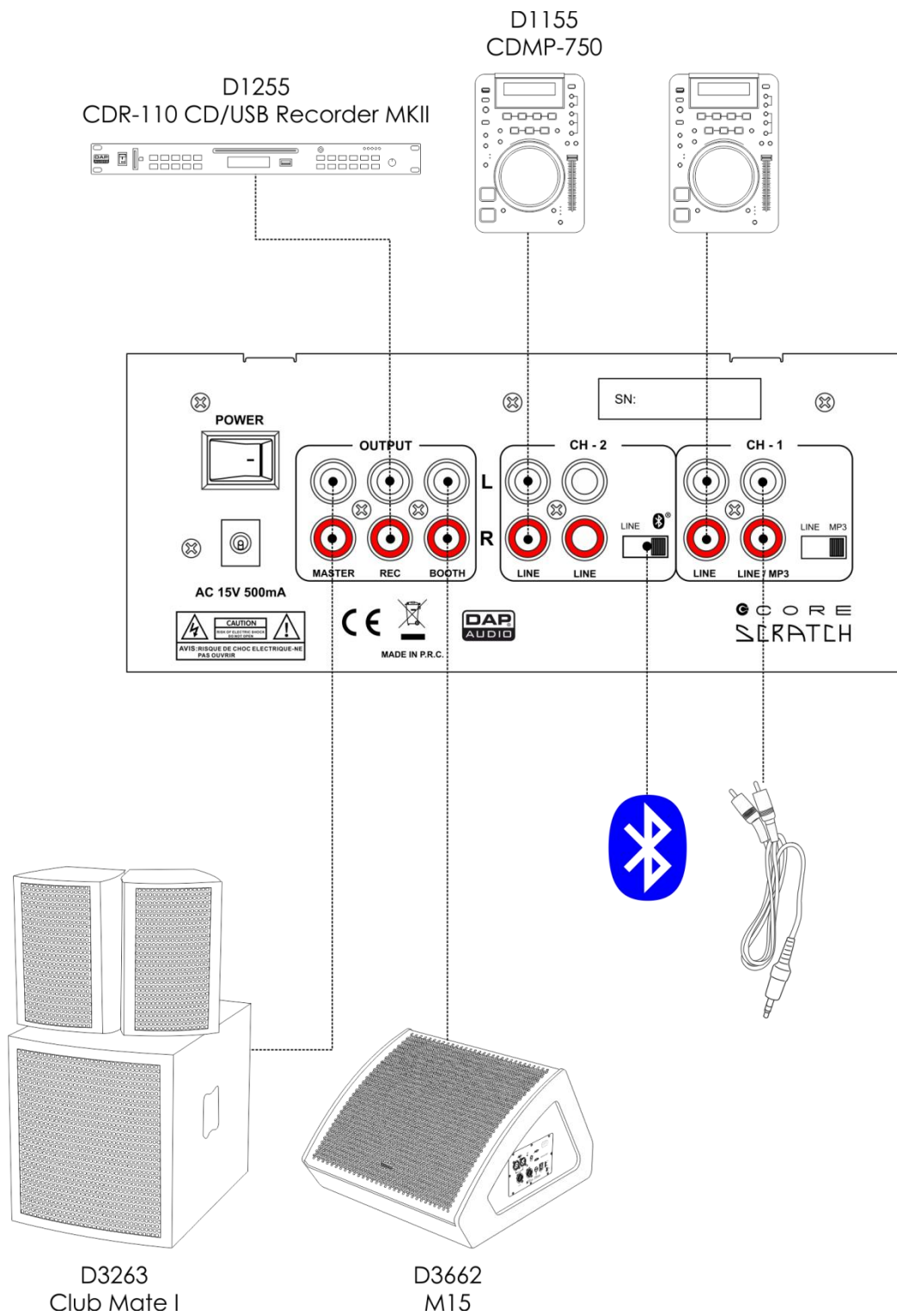

Connection Cables

Take care of your cables, always holding them by the connectors and avoiding knots and twists when coiling them: This gives the advantage of increasing their life and reliability. Periodically check your cables. A great number of problems (faulty contacts, ground hum, discharges, etc.) are caused entirely by using unsuitable or faulty cables.

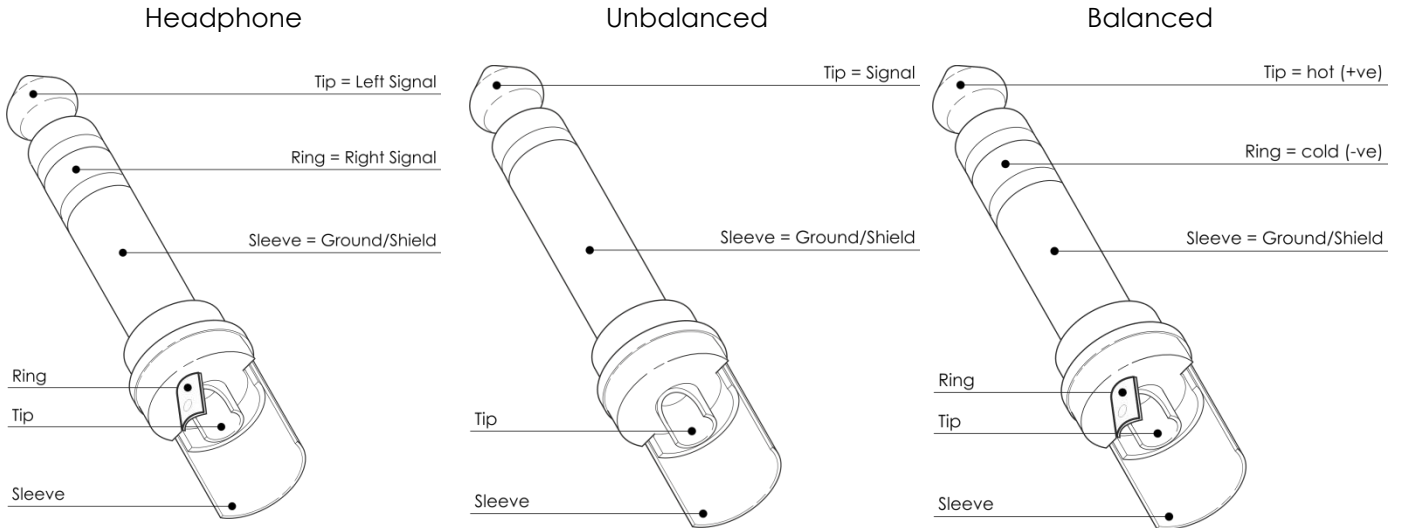

For these applications the unit provides 1/4" TRS and XLR connectors to easily interface with most professional audio devices. Follow the configuration examples below for your particular connection.

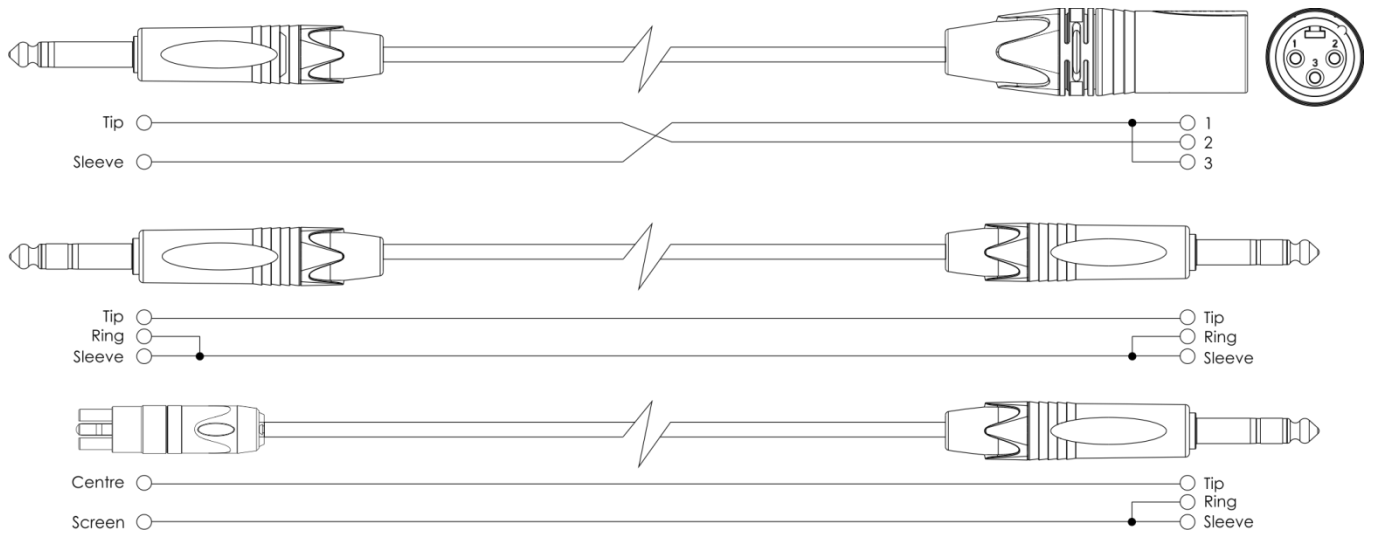

Connect a Bluetooth device

1. Turn on your Bluetooth device.
2. Power on the DAP Audio Core Scratch.
3. Press the Pair/Unpair button on the DAP Audio Core Scratch.
4. Navigate to your Bluetooth device's setup screen, find "BT CORE" and connect.
Note: If your Bluetooth device prompts for a pairing code, enter '0000'.
5. The DAP Audio Core Scratch pairing LED will light up solid when it is 'paired'.
Note: If your Bluetooth device is not able to pair to the mixer, press the Pair/Unpair button on the mixer to break previous Bluetooth connections and reset the Bluetooth module.
6. To disconnect pairing, press the Pair/Unpair button on the DAP Audio Core Scratch.
7. To connect to a different Bluetooth device, repeat steps 4-5.

Maintenance

The Dap Audio Core Scratch requires almost no maintenance. However, you should keep the unit clean. Disconnect the mains power supply and then wipe the cover with a damp cloth. Do not immerse in liquid. Do not use alcohol or solvents.

Keep connections clean. Disconnect electric power and then wipe the connections with a damp cloth. Make sure connections are thoroughly dry before linking equipment or supplying electric power.

Troubleshooting

DAP Audio Core Scratch

This troubleshooting guide is meant to help solve simple problems. If a problem occurs, carry out the steps below in sequence until a solution is found. Once the unit operates properly, do not carry out following steps.

1. If the device does not operate properly, unplug the device.
2. Check power from the wall, all cables, connections, etc.
3. If all of the above appears to be O.K., plug the unit in again.
4. If nothing happens after 30 seconds, unplug the device.
5. Return the device to your DAP Audio dealer.

Product Specifications

Model:	DAP Audio Core Scratch	
Input Channels:	1x Microphone, combo XLR/Jack 4x Line RCA 1x Bluetooth	
Output channels:	1x Record, RCA 1x Booth, RCA 1x Master unbalanced, RCA 1x Headphones, TRS 6.3mm Jack	
Channel EQ:	High frequency:	10 kHz
	High range:	-26dB to +12dB
	Mid frequency:	1 kHz
	Mid range:	-26dB to +12dB
	Low frequency:	100 Hz
	Low range:	-26dB to +12dB
Microphone EQ:	High frequency:	10 kHz
	High range:	-26dB to +12dB
	Low frequency:	100 Hz
	Low range:	-26dB to +12dB
Frequency Response:	Microphone:	20 Hz to 20 kHz(+ -3dBu)
	CD/Line:	20 Hz to 20 kHz(+ -1.5dBu)
Signal-to-noise Ratio:	Microphone:	>80dB
	CD/Line:	>85dB
Distortion Rate:	CD/Line:	<0.05 %
Cross Talk:	Cross Talk(1k) >75dB	
Power input:	AC15V/500mA	
Power consumption:	5W	

Dimensions

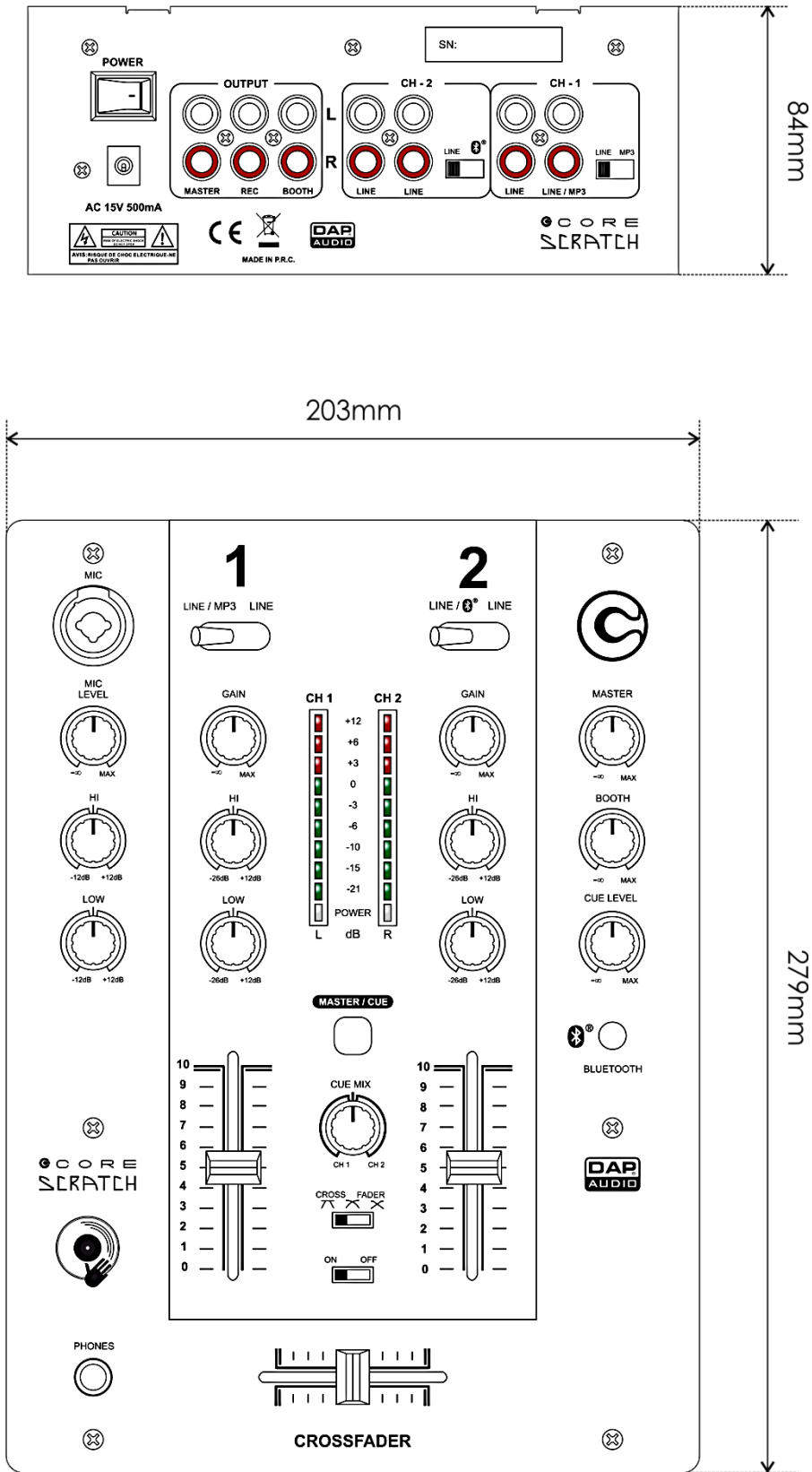



©2013 DAP Audio