



 **NERO**
MONITOR CONTROLLER
User Manual V3.0

Thank you for choosing this Audient product

Nero has been designed to deliver pristine sound quality whilst giving you powerful control over your monitoring.

Featuring a comprehensive range of I/O, console style monitor control, Precision Matched Attenuation Technology, an assignable sub output and Smart Touchpoints.

With the incredible flexibility and customisability provided, Nero will sit comfortably at the core of your studio.

Features Include:

- 4 x Stereo Analogue sources
 - 2 x Line Level Inputs
 - 1 x Dedicated Cue Mix Input
 - 1 x Aux Input (RCA or Mini Jack)
- Optical & Coaxial S/PDIF Inputs
- 3 x Stereo Speaker Outputs
- 1 x Assignable Sub Output
- 4 x Headphone Outputs with flexible routing
- Smart Touchpoints for user customisation
- Talkback Input
- Internal Microphone
- External Talkback Input
- Dim, Cut, Mono & Polarity Monitor Controls



Welcome and Thank you	2
Nero Overview	4
Box Contents	6
Safety Information	7
Declaration of Conformities	9
Setup Diagrams	11
Hardware Features:	14
Power Switch	15
Inputs	16
Outputs	17
Routing	18
Input Selection	18
Speaker Output Selection	19
Volume Control	20
Monitoring Functions	20
Talkback	21
Saving your Routing	22
Factory Reset	22
Smart Touchpoints	23
Speaker Level Matching	23
Smart Mono Mode	24
Assignable Sub	24
User Defined Dim	25
Talkback Routing	25
Signal Flow Diagrams	26
Technical Specifications	28
Warranty & Contact	29
Service	31
Glossary	32

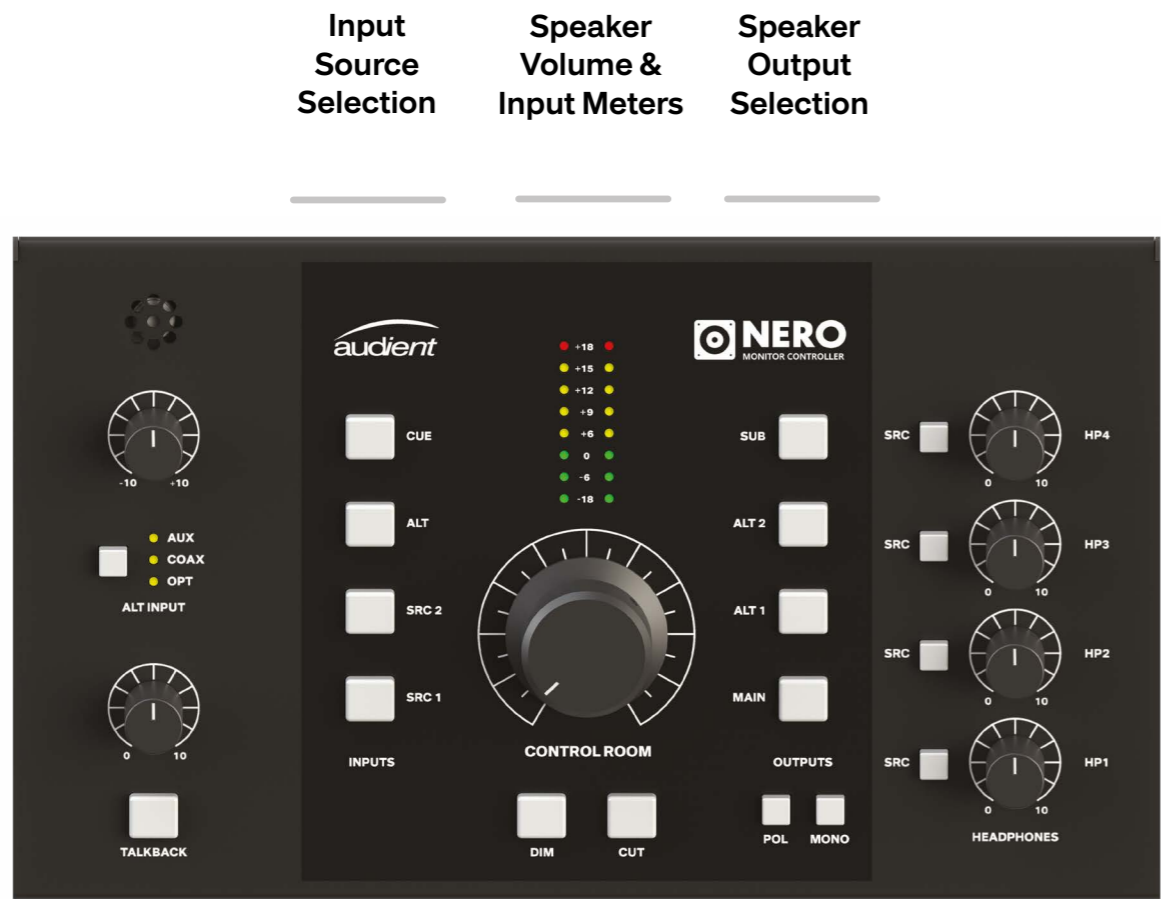

Input Source Selection

Speaker Volume & Input Meters

Speaker Output Selection

Aux Input Trim and Alt Input Selection

Talkback Mic Gain & On/Off Switch

Speaker Cut and Dim Controls

Mono and Polarity Flip of Left Channel

Headphone Source Selection Buttons & Volume Controls



S/PDIF Inputs

Sub Output

External Talkback Input

Power Switch & DC Input

Headphone Outputs 2-4

Speaker Outputs

Analogue Input Sources

Talkback Mic Selector

Inside your Nero packaging you will find the following items:

- Nero
- 12V Switch Mode Power Supply with Regional Adaptors
- Quick Start Guide

Please visit audient.com/nero to download the latest supporting documentation and brochures for our product range.

The 12V DC power supply comes with interchangeable UK, EU, US and Australian Socket Adaptors and will work across a broad range of Mains Voltages, making Nero globally portable.

We hope that you enjoy using Nero!



Important Safety Instructions

Please read all of these instructions and save them for later reference before connecting the DC power adapter to the mains and powering up Nero.

To prevent electrical shock and fire hazard follow all instructions on the 12VDC power supply. Nero itself does not operate with any high voltage mains supply inside the unit but appropriate safety measures should still be adhered to regarding the AC/DC supply.

Please ensure you only use the included Nero power supply. We cannot recommend the usage of third party power supplies. In the event of a power supply failure do not open the 12VDC supply. If required, please contact Audient support so that a suitable replacement can be sourced.

audient.com/support

Nero utilises an external switch-mode power supply that is very quiet and rated at 2A. This switch-mode design will accept any A.C line voltage from 100v to 240v @ 50/60Hz. Therefore the unit will work anywhere in the world but please ensure your A.C mains line voltage is within this specification.

Consult a qualified technician if you suspect difficulties. Do not attempt to tamper with the power supply or mains voltages - **HAZARDOUS TO HEALTH**. Ensure that the appropriate international pin adapter is fitted to the power supply before insertion into the mains socket.

! WARNING !

TO REDUCE RISK OF FIRE OR ELECTRIC SHOCK, DO NOT EXPOSE THIS APPARATUS TO RAIN OR MOISTURE.

NO USER SERVICEABLE PARTS INSIDE.

PLEASE REFER SERVICING TO QUALIFIED SERVICE PERSONNEL.

Important Safety Instructions

1. Read these instructions
2. Keep these instructions
3. Heed all warnings
4. Follow all instructions
5. Do not use this equipment near water
6. Clean only with dry cloth
7. Do not install near any heat sources such as radiators, heat registers, stoves, or other equipment (including amplifiers) that produce heat
8. Do not defeat the safety purpose of the polarized or grounding-type plug. A polarized plug has two blades with one wider than the other. A grounding type plug has two blades and a third grounding prong. The wide blade or the third prong are provided for your safety. If the provided plug does not fit into your outlet, consult an electrician for replacement of the obsolete outlet
9. Protect power cords from being walked on or pinched particularly at plugs, convenience receptacles, and the point where they exit from the equipment. Only use attachments/accessories specified by the manufacturer
10. Unplug this equipment during lightning storms or when unused for long periods of time
11. Refer all servicing to qualified service personnel. Servicing is required when the equipment has been damaged in any way, such as power supply cord or plug is damaged, liquid has been spilled or objects have fallen into the equipment, the equipment has been exposed to rain or moisture, does not operate normally, or has been dropped
12. For products that are a mains powered device: The equipment shall not be exposed to dripping or splashing and no objects filled with liquids (such as vases) shall be placed on the equipment.

FCC Part 15B

This apparatus has been tested and found to comply with the limits of a class-A digital device, pursuant to Part 15B of the FCC Rules. These limits are designed to provide reasonable protection against harmful interference in a residential installation. This equipment generates, uses and can radiate radio frequency energy and, if not installed and used in accordance with the instructions, may cause harmful interference to radio communications. If this equipment does cause harmful interference to radio or television reception, which can be determined by turning the equipment off and on, the user is encouraged to try to correct the interference by one or more of the following measures:

1. Re-orient or relocate the receiving antenna
2. Increase the separation between the equipment and receiver
3. Connect the equipment into an outlet on a different circuit from that to which the receiver is connected.
4. Consult the dealer or an experienced radio/TV technician for help

Declaration of Conformities



We, Audient Ltd, Aspect House, Herriard, Hampshire, RG25 2PN, UK, 01256 381944, declare under our sole responsibility that the product Nero complies with Part 15 of FCC Rules.

Operation is subject to the following two conditions:

1. This device may not cause harmful interference,
2. This device must accept any interference received, including interference that may cause undesired operation



We, Audient Ltd, declare that the product, Nero, to which this declaration relates, is in material conformity with the appropriate CE standards and directives for an audio product designed for consumer use.



Audient Ltd has conformed where applicable, to the European Union's Directive 2002/95/EC on Restrictions of Hazardous Substances (RoHS) as well as the following sections of California law which refer to RoHS, namely sections 25214.10, 25214.10.2, and 58012, Health and Safety Code; Section 42475.2, Public Resources



Please note that Audient Nero is exempt from the EC 1275/2008 power management requirement for the following reason:

Nero is designed with the analogue line inputs being the primary functional input of the device. When an input device is connected, Nero must be active to wait for a signal. During a recording or mixing session it can be a long time until audio is actually played. If Nero were to go into a standby mode or similar, this would cause a disruption to a recording session as the user would expect the unit to be operational even if the input is not being actively used.



Setup Diagrams



Analogue Feed from Interface and CD Player



Digital Feed from Interface

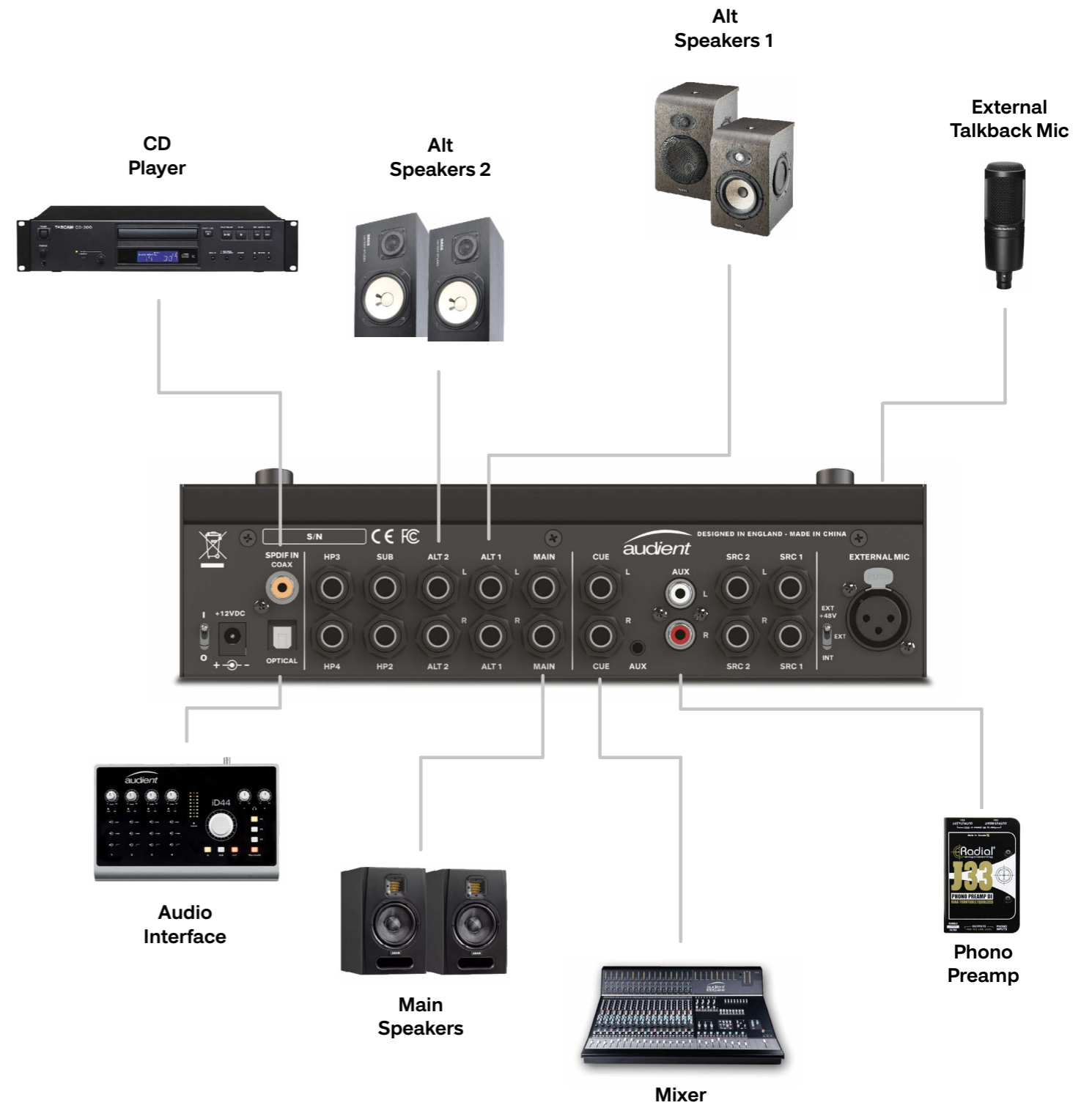



Hardware Features



The Power Switch

The rear panel power switch can be used to turn the unit on and off - this is pretty self explanatory, but always remember that your speakers or power amps should be turned off when turning Nero (or any other device in the signal chain) on or off.



Inputs

Nero features an array of input options enabling you to connect to a range of different devices. The input connections are used to send audio to Nero where it can be monitored.

SRC 1 & 2

SRC 1 & 2 are analogue TRS balanced line inputs and can be connected to any analogue line output device. Typically SRC 1 would be the main input used for monitoring and fed from the stereo outputs on your audio interface.



Alt Input

There are three independent Alt inputs; two digital inputs and an analogue Aux input.

To switch between the Alt inputs use the Alt input button found on the front of Nero.

Analogue Inputs

The Aux input features both RCA inputs and a mini-jack input that allow you to connect devices such as a CD player or a mobile phone.

When both the RCA and mini-jack inputs are connected, the RCA inputs will always be overridden by the mini-jack input.

Use the trim knob to quickly set and match the input level to other inputs, this is useful when dealing with line level inputs coming in hot.



Digital Inputs

The two S/PDIF inputs are an Optical and an Coax, supporting samples rates up to 192kHz. This enables you to connect to devices such as audio interfaces.



When using the S/PDIF inputs Nero will automatically lock to a valid incoming signal.

If the source is selected but no valid input is detected the corresponding LED will flash. Ensure that you are correctly sending audio from the right outputs on your device.

If the signal is locked the LED will stop flashing and remain illuminated.



Cue Input

Like SRC 1 and 2 the Cue input accepts a balanced line level signal using TRS jacks. Typically it would be used to provide a foldback mix for the artists.



Outputs

Nero features a vast choice of outputs enabling you to centralise your setup and take control of your monitoring needs.



Main Output

The main output is typically used to connect to your main set of speakers. The connectors are analogue TRS balanced line outputs.

Alt Outputs

There are two pairs of Alt outputs which can be used to plug in two more pairs of speakers. This is a great way to quickly reference your mixes on different types of speakers. The connectors are analogue TRS balanced line outputs.

Sub Output

The sub output is used to connect your sub woofer, enabling you to check the low-end on your mixes.

Headphone Outputs

Nero features one monitor grade headphone output on the front of the unit. This would typically be used by the engineer to reference their mixes on headphones or to run recording sessions.

There are also three foldback grade headphone outputs for your artists. This enables you to send different inputs and foldback mixes to your artists.



Routing

A key feature of monitor controllers is signal routing. Nero provides great flexibility for speaker and headphone routing.

Input Selection

Control Room

When assigning an input to a control room output the active input button on the front panel is illuminated orange to indicate that input is active.



Headphone Outputs

Input sources

In order to route an input to a specific headphone output you will need to use the SRC button located next to the headphone volume pots. Press the SRC to put it into headphone source mode. This is indicated by the SRC and Input Select LEDs illuminating green.

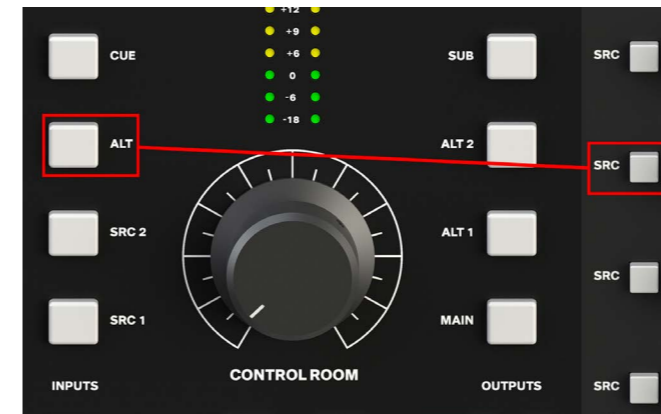

You can now select the desired input by pressing the corresponding input button.

HP1 has a special mode to allow it to follow the control room source.

1. Press the currently active input button
2. All input LEDs are off when following the control room input
3. Talkback is not available when in this mode

Note: HP1 defaults to following the control room source. HP2-4 default to the Cue Input.

Talkback Routing

When in headphone source mode you can also toggle the Talkback button to route or unroute the talkback signal to that headphone output.



Note: By default Talkback is routed to HP2-4.

Speaker Output Selection

To to select which set of speakers you want to listen through, use the selection buttons found in the control room section of the front panel.



Volume control

The speaker output volume is controlled by the main large volume knob. This controls a stepped volume attenuator - ensuring the left and right outputs remain perfectly matched no-matter what position the knob is in.



Monitoring Functions

Nero uses our expertise in consoles to provide console style monitoring to give you total control.

Dim

When the Dim function is active it will reduce the output volume to your speakers by a preset amount. This defaults to -15dB but can be adjusted to taste.



Cut

Turns all speakers off - perfect for when you need to quickly talk to the artists or just listen on headphones.



Mono

Mono sums the Left and Right channels of your stereo signal together to check compatibility with Mono speakers. This is as important as ever with people listening on bluetooth speakers or phones with a single speaker.

The button can also be held down for momentary operation.



Polarity

This flips the polarity (or phase) of the Left input. Used together with Mono this allows you to listen to the sides of your mix. This is useful for checking your stereo reverbs and delays.

This button can also be held down for momentary operation



Talkback

The talkback function allows you to communicate with the artist in the live room or vocal booth by feeding a microphone signal from the control room into their headphone mix.



Nero provides an internal talkback microphone and the ability to connect to an external talkback microphone.



The rear panel switch allows you to select between:

- Internal microphone
- External microphone connected to the XLR input - generally for dynamic microphones
- External microphone connected to the XLR input with phantom power - generally for condenser microphones

Gain Knob

The talkback preamp provides a wide gain range to allow for good levels from a range of different microphones. Use the gain knob to set your talkback level to a comfortable listening level for your artists.

Talkback Button

This button activates talkback - feeding the signal to the headphone outputs that it has been assigned to.

It will also engage the Control Room DIM function to prevent feedback and provide a clearer talkback signal to your artist.

Saving your Routing

You may want to save your routing set-up so that your Nero automatically powers up in that configuration next time you power it on.

To save the routing state press the active speaker output button and any other speaker output button simultaneously.

A successful save will be indicated by the DIM (green) and Cut (red) LEDs flashing.



Factory Reset

In order to reset your Nero to the factory default settings use the following procedure:

1. Power off the unit
2. Hold down both the DIM and CUT buttons and continue holding them
3. Power the unit back on using the power switch



4. After 3 seconds release the DIM and CUT buttons

The unit should now be reset.

Smart Touchpoints

Smart Touchpoints enable you to configure different routing options for your monitoring quickly.

Easily route and configure Nero's outputs and monitor controls to create monitoring combinations that suit your needs. Simply hold down a Smart Touchpoint to put it into setup mode, select your routing options and press it again to save.

Speaker Level Matching

When switching between different speakers it is common to experience a variation in volume levels. This is caused by differences in power amp sensitivity, it is common to have to calibrate your speakers or power amps.

In order to counter this issue we have integrated speaker trim functionality into Nero's ALT speaker outputs so they can be matched to the level of your Main speakers.



To calibrate the speakers we recommend using a pink noise generator and some form of SPL meter. To match the levels of your speakers follow these steps:

1. Feed out pink noise to your main speakers
2. Take a note of the SPL level
3. Select the ALT Speaker output you're wanting to calibrate, hold that button down until the button starts flashing to indicate you're in setup mode
4. Rotate the volume control up or down to trim the level until it matches the reading you noted down from your main speakers
5. Press the flashing Alt speaker button again to save the calibration

Please note Nero provides a range of $\pm 15\text{dB}$ which in most cases is more than enough. However if your speakers are massively out please check if your power amp or speakers provide trim controls, if not consider purchasing in-line attenuators (pads).

Smart Mono Mode

Nero enables you to configure a speaker output as mono - this saves you from having to toggle the Mono function each time you switch to your mono speaker.

To set this up follow these steps:

1. Hold down the button for the speaker output you would like to configure as mono until it flashes, indicating it is in setup mode
2. Press the Mono button
3. Press the flashing speaker output button again to save the setting

Example

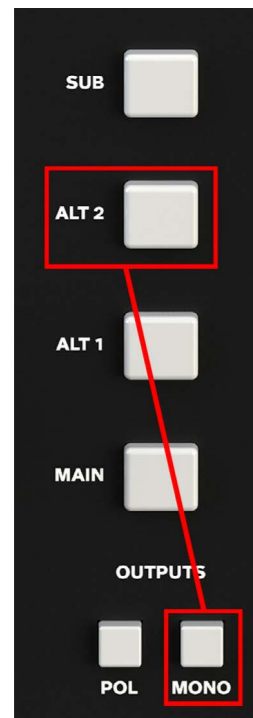

Once this is set up Mono will be activated in the background each time you switch to that speaker - but the Mono button will not illuminate.

Please note that when using other speaker outputs it is still possible to toggle the Mono button on and off.

Assignable Sub Output

You can link the Sub output with any of the speaker outputs so it is automatically activated when you switch to that speaker output

To set this up follow these steps:

1. Hold down the button for the speaker output you would like to configure as Mono until it flashes, indicating it is in setup mode
2. Press the Sub button
3. Press the flashing speaker output button again to save the setting

Example

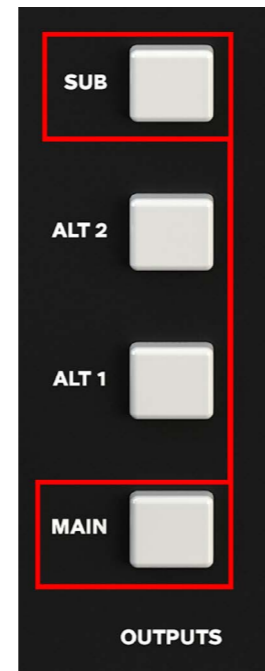

The sub output will now activate automatically when switching to that output.

Please note it is still possible to toggle the sub output on and off by pressing the sub button without losing your saved routing preset.

User Defined Dim

The amount of attenuation provided on Nero defaults to -15dB, but you can adjust this to your taste.

To adjust this follow these steps:

1. Hold down the Dim button until it flashes, indicating it is in setup mode
2. Rotate the volume knob to the desired volume
3. Press the Dim button again to save the setting.



Talkback Routing

Nero gives you ultimate flexibility with talkback routing - you can assign it to each of the headphone outs independently

To assign the talkback mic to a headphone output follow these steps:

1. Press the headphone output source button
2. Press the talkback button - if it is illuminated red talkback is assigned to that output
3. Bear in mind that this means you can't activate Talkback when in Headphone source select mode



Example

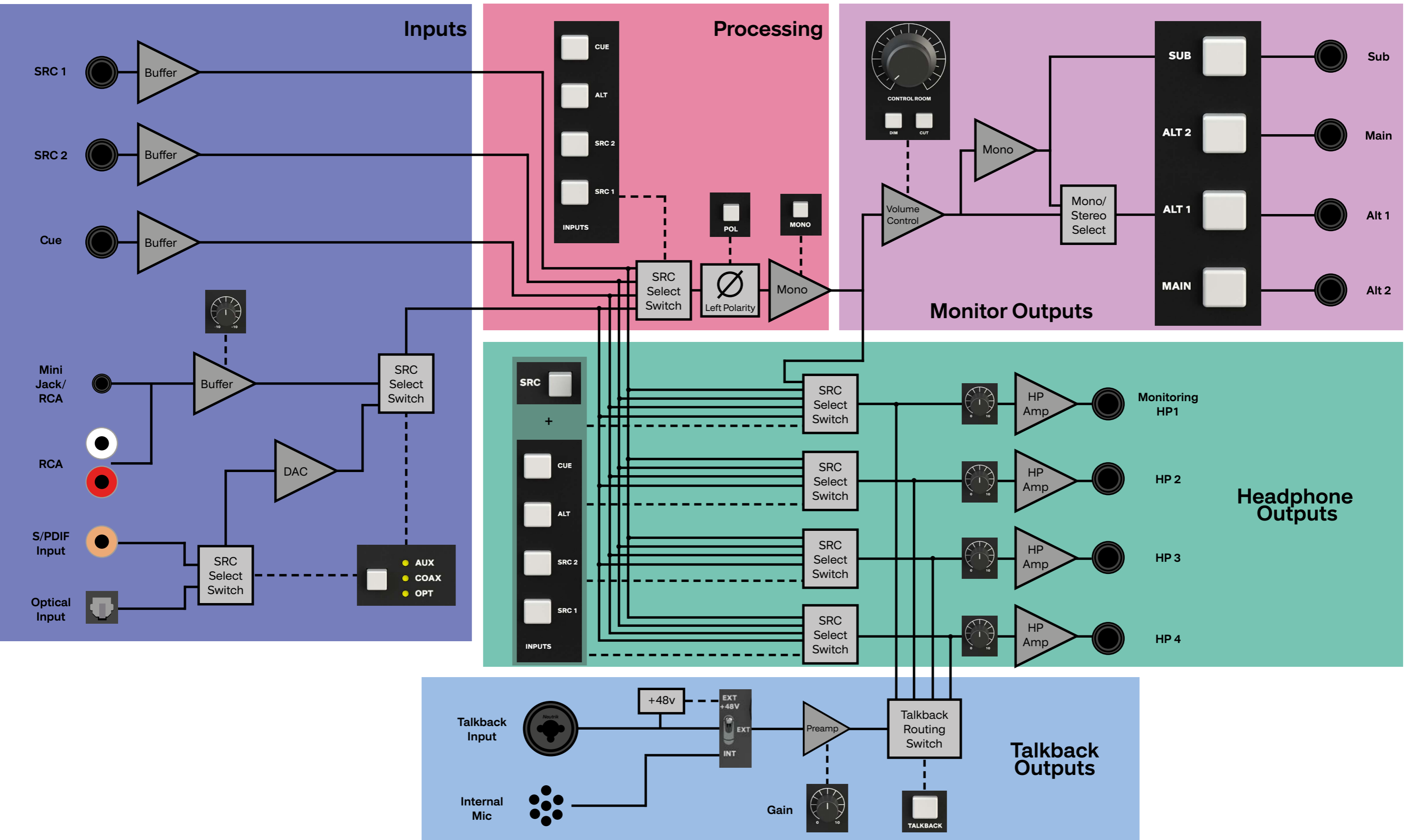

BALANCED LINE INPUTS:

NORMAL INPUT LEVEL: +4dBu
MAX INPUT LEVEL: +18dBu
CMRR: >50dB
MIC EIN: -128dBu
CMRR: >80dB @ 1kHz

UNBALANCED AUX INPUTS:

NOMINAL INPUT LEVEL: -10dBV
MAXIMUM INPUT LEVEL (minimum trim): +27dBu
TRIM RANGE +12dB

DIGITAL INPUTS:

INPUTS: TOSLINK and Coaxial
FORMAT: S/PDIF
SAMPLE RATE: 44.1kHz - 192kHz
BIT DEPTH: up to 24bit

TALKBACK INPUTS:

MAXIMUM INPUT LEVEL: 2dBu
GAIN: 4-44dB
PHANTOM POWER: +48V

SPEAKER OUTPUTS:

MAXIMUM OUTPUT LEVEL: +12dBu

HEADPHONE OUTPUTS:

MINIMUM LOAD: +12.8Ohms

PERFORMANCE

SPEAKER OUTPUTS:

THD+N: +0.0015% 0dBu
SNR: 100dBu
CROSSTALK (SPEAKERS): >100dB
FREQUENCY RESPONSE: 20Hz - 22kHz + 0.5dB
ATTENUATION AT MIN VOLUME:
(SPEAKER OUTPUTS) >110dB

DAC:

THD+N: <0.0017%
DYNAMIC RANGE: 113dB
FREQUENCY RESPONSE: 20Hz - 22kHz +0.5dB

HEADPHONE OUTPUTS:

THD+N @ 0dBu (output level):
0.009% - 300hm
0.009% - 600hm
0.008% - 600hm

PEAK POWER OUTPUT:

90mW - 300hm
56mW - 600hm
7.35mW - 600OHM
CROSSTALK >62dB
ATTENUATION AT MIN VOLUME: >96dB

POWER SUPPLY:

12VDC Centre Positive DC Adapter - 2Amps

WEIGHTS & DIMS:

Weights:Unit: 2.0kg

Unit Dimensions:

255mm (w) x 75mm (h) x 155mm (d)

Warranty

The Audient warranty period for any product purchased is 12 months from the date of the original purchase.

- The warranty is not transferable to a second user.
- Audient products are built using the latest manufacturing technology, tested to the highest possible standards and by using premium components this should result in providing you with reliable performance for many years.
- The warranty is return to base, meaning the unit must be returned, carriage paid, to the Dealer you purchased the unit from or the exclusive territory Distributor responsible for the country in which you purchased the product
- Some of the products returned under warranty are found not to exhibit any fault at all when they are retested at our Service Centre's so it's always useful to contact our Support team first to try to avoid inconvenience to you at support@audient.com
- If you suspect that your unit is suffering from a component or manufacturing defect during the warranty period please contact either Audient support or the dealer that you purchased the Audient product from
- In the event of a component or manufacturing defect becoming evident during the warranty period, Audient will ensure that the product is repaired free of charge or replaced
- Whilst this warranty is provided by Audient, the warranty obligations are fulfilled by the exclusive territory Distributor responsible for the country in which you purchased the product.
- The Dealer will advise you of the appropriate procedure for resolving the warranty issue.
- In every case it will be necessary to provide a copy of the original invoice or Dealer purchase receipt to the Distributor.
- In the event that you are unable to provide proof of purchase directly then you should contact the Dealer from whom you purchased the product and attempt to obtain proof of purchase from them. The Dealer | Distributor will then advise the procedure to follow.
- This limited warranty is offered solely to products purchased from an Authorised Audient Dealer (defined as a Dealer which has purchased the product directly from Audient in the UK, or one of our Authorised Distributors outside the UK).

Please note that if you purchased the product from outside of your country of residence you must return the unit to the original point of purchase for repair.

The Audient warranty term is additional to any statutory rights in the country of purchase or as offered by the dealer at the time of purchase.

What is meant by a Manufacturing Defect ?

We define this as a defect in the performance or specification of the product as described and published by Audient.

A Manufacturing Defect does not include damage caused by post-purchase shipping, storage or careless handling, nor damage caused by misuse.

Tel: 0044 1256 381944

audient.com



Service Information

Nero contains no user-serviceable components, please refer to qualified service personnel for diagnosis and repair. Your warranty will be void if you tamper with the device at component level. If you have any questions with regard to the repair, please contact Audient Ltd.

If your unit is in warranty, please contact your dealer directly for a repair or replacement (at the discretion of the dealer).

For out of warranty repairs, please contact Audient Ltd, after which a Return Materials Authorization (RMA) number will be assigned. This number will serve as a reference for you and helps facilitate and expedite the return process. When the unit is returned please include this RMA number along with a description of the fault inside the packaging box.

To request an RMA, access technical support & FAQs, ask for troubleshooting assistance or make an enquiry, please visit: audient.com/support

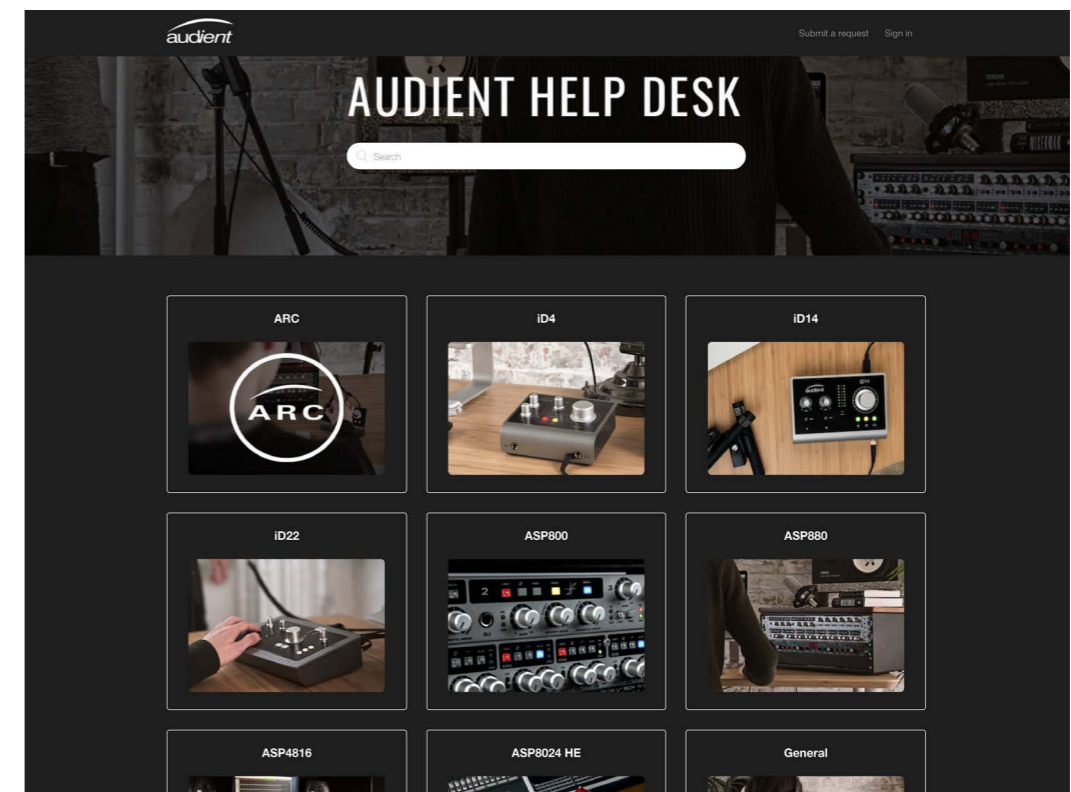

Glossary

Below are a list of common words you may encounter in this manual or whilst using Nero.

A	Amperes
DAW	Digital Audio Workstation
CUE	Artist Headphone Mix
DAC	Digital to Analogue Converter
dB	Decibel
dBu	Decibel referenced to 0.775Vrms = 0 dBu
dBFS	Decibel Full Scale
DC	Direct Current
DoC	Declaration of Conformity
FAQ	Frequently Asked Questions
FCC	Federal Communications Commission
I/O	Input / Output
LED	Light Emitting Diode
RoHS	Restriction of Hazardous Substances
S/PDIF	Sony Philips Digital Interface Format
THD+N	Total Harmonic Distortion + Noise
TRS	Tip Ring Sleeve (1/4" Jack Balanced)
TS	Tip Sleeve (1/4" Jack Unbalanced)
V	Volts
XLR	Extra Live Return, Extremely Low Resistance, Canon X Series, Latching, Resilient Rubber Compound... or make up your own!

